

P&T MOTORS, BRACKETS



WCWA

CORNER MOUNT ADAPTOR

Made of steel

Load rating: 30kg (66lb)



WCWA

WCWGC

CORNER MOUNT ADAPTOR

Made of steel

Load rating: 50kg (110lb)



WCWGC

PTAC

WALL MOUNT FOR PTH300 SERIES AND LIGHT DUTY P&T MOTORS

Made of aluminium

Load rating: 35kg (77lb)

Length: 360mm (14.2in)



PTAC

PTCC1

POLE MOUNT ADAPTOR

Made of aluminium

For pole diameters: from 80mm (3.1in) up to 150mm (5.9in)

Load rating: 50kg (110lb)



PTCC1

WFWBTA

PARAPET BRACKET

Made of aluminium

Load rating: 50kg (110lb)

Length: 185mm (7.3in)



WFWBTA

WSFPA

POLE MOUNT ADAPTOR

Made of aluminium

Load rating: 30kg (66lb)

For pole diameters: 65÷110mm (2.6÷4.3in)



WSFPA

WCPA

REINFORCING SUPPORT PLATE FOR POOR CONSISTENCY WALLS

Made of aluminium

Available with a supporting box with internal cable channel

Load rating: 50kg (110lb)



WCPA

TECHNICAL DATA

WCWA

MECHANICAL

Made of steel
Load rating: 30kg (66lb)

PART NUMBER

WCWA Corner mount adaptor

PACKAGE

Model Number	Weight	Dimensions (WxHxL)	Master carton
WCWA	1.1kg (2.2lb)	14.5x15x27cm (6x6x11in)	15

WCWGC

MECHANICAL

Made of steel
Load rating: 50kg (110lb)
Unit weight: 2.2kg (4.8lb)

PART NUMBER

WCWGC Corner mount adaptor

PACKAGE

Model Number	Weight	Dimensions (WxHxL)	Master carton
WCWGC	2.6kg (5.7lb)	24x32x24.5cm (9.4x12.6x9.6in)	8

PTAC

MECHANICAL

Made of aluminium
Load rating: 35kg (77lb)
Unit weight: 0.7kg (1,5lb)

PART NUMBER

PTAC Wall bracket for PTH300 series

PACKAGE

Model Number	Weight	Dimensions (WxHxL)	Master carton
PTAC	0.9kg (2lb)	13.5x13.5x45cm (5x5x18in)	10

PTCC1

MECHANICAL

Made of aluminium
For pole diameters: 80÷150mm (3÷5.9in)
Load rating: 50kg (110lb)
Unit weight: 2.6kg (5.7lb)

PART NUMBER

PTCC1 Pole mount adaptor

PACKAGE

Model Number	Weight	Dimensions (WxHxL)	Master carton
PTCC1	2.8kg (6.2lb)	14x25.5x20cm (5.5x10x7.9in)	8

WFWBTA

MECHANICAL

Made of aluminium
Load rating: 50kg (110lb)
Height: 185mm (7.3in)
Unit weight: 0.8kg (1.8lb)

PART NUMBER

WFWBTA Column bracket for PTH P&T series

PACKAGE

Model Number	Weight	Dimensions (WxHxL)	Master carton
WFWBTA	1kg (2.2lb)	14.3x15x27cm (5.5x6x11in)	15

WSFPA

MECHANICAL

Made of aluminium
Allows the internal cable management
Load rating: 30kg (66lb)
For pole diameters: 65÷110mm (2.6÷4.3in)
Unit weight: 0.9kg (2lb)

PART NUMBER

WSFPA Pole mount adaptor

PACKAGE

Model Number	Weight	Dimensions (WxHxL)	Master carton
WSFPA	1kg (2.2lb)	10x16x23cm (4x6x9in)	15

WCPA

MECHANICAL

Made of aluminium
Available with a supporting box with internal cable channel (WBOV3A2)
Load rating: 50kg (110lb)
Unit weight: 0.6kg (1.3lb)

PART NUMBER

WCPA Reinforcing support plate for poor consistency walls

PACKAGE

Model Number	Weight	Dimensions (WxHxL)	Master carton
WCPA	0.7kg (1,5lb)	10x16x23cm (4x6x9in)	30

TECHNICAL DRAWINGS

The dimensions of the drawings are in millimetres.

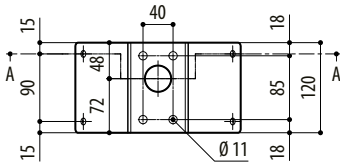
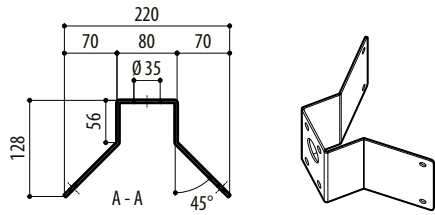

WCWA

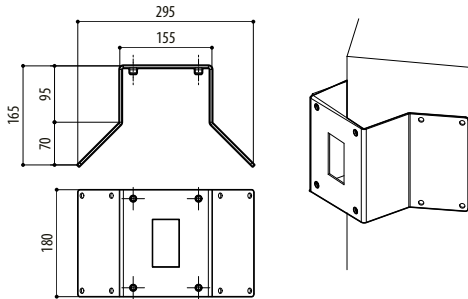

WCWGC

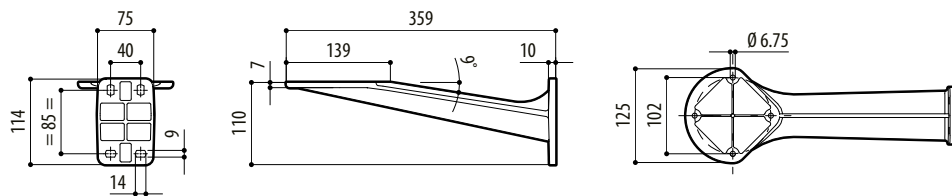

PTAC

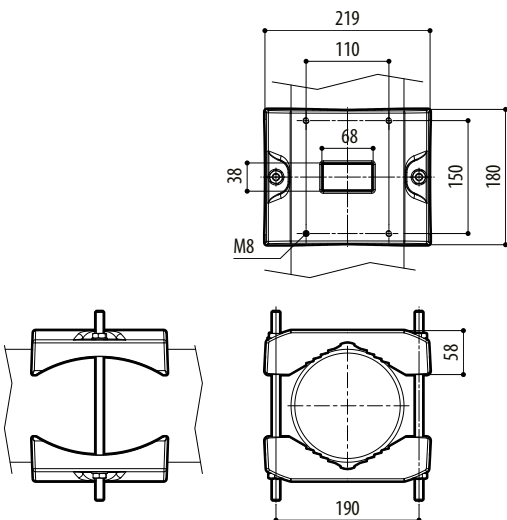

PTCC1

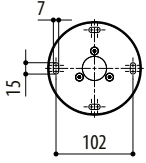
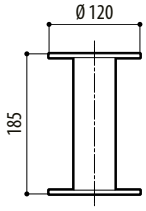

WFWBTA

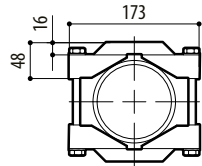
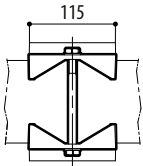
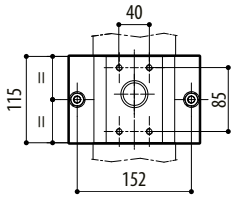

WSFPA

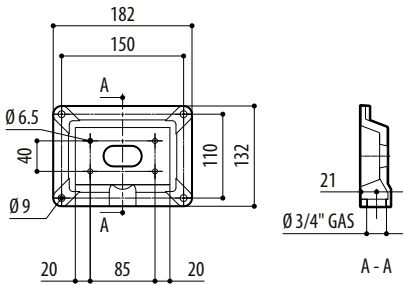

WCPA